

OLIVER BONAS

TIENDA CHEST OF DRAWERS

HARDWARE

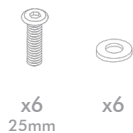

TOOLS:

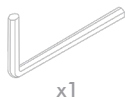

COMPONENTS

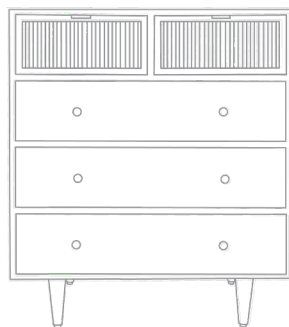
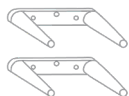
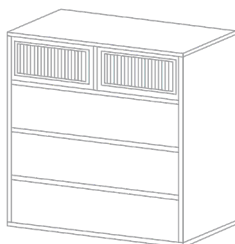

INSTRUCTIONS

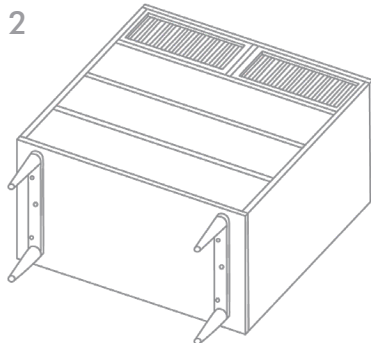
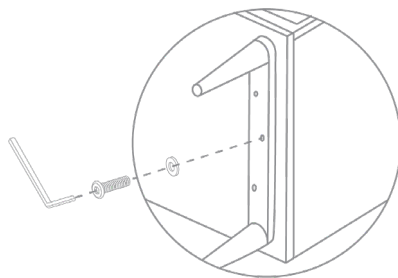
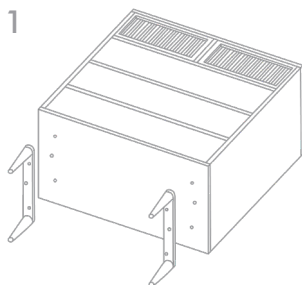

OLIVER BONAS

Furniture Care Information

We hope you love your purchase, however if you aren't completely happy please retain your packaging to ensure its safe return.

MANGO WOOD with GLASS PANELS

Each piece has been individually handcrafted to create a unique piece of furniture.

PROPERTIES OF MANGO WOOD

Mango wood is a hardwood timber. Mango wood is coarse in texture and its colour varies from light to dark brown. Natural variation may occur adding charm to each piece.

CARING FOR YOUR WOODEN FURNITURE

Wood is a natural material.

During warm, humid weather wood can expand.

During dry weather wood contracts.

These seasonal variations are a normal characteristic of wood.

To help maintain the natural beauty and performance of your piece of furniture do not position in front of radiators, avoid direct heat, direct sunlight, moist environments and outdoor use.

If drawer or doors do expand please try the following to resolve:

Using a fine to medium coarse sandpaper, light sand the affected edges. Applying a little candle wax/furniture wax, they will help your drawer run smoothly again.

TOUGHENED GLASS

Wipe with a damp cloth, followed by a soft, dry cloth. Do not use harsh abrasives or household cleaners as they may scratch and damage the finish

FABRIC

Assemble with care to avoid damaging the fabric.

WARNING!

Be careful when applying any wax to natural unfinished wood as staining may occur.

Any spills should be removed immediately. Never let them dry out on the surface.

For stubborn stains, gently sand the full surface area to help maintain an even and smooth finish.

To maintain the appearance of your wooden furniture, we suggest regular dusting with a soft cloth.

Take care when moving the furniture.

Do not drag furniture as it may cause damage to the joints.

Please note, the above are guidelines only.

Periodically check fittings as they may come loose over time.

Designed for domestic use only.

Please retain this information for future reference.